

**CONSENT AND DEVELOPMENT AGREEMENT BETWEEN THE CITY OF KYLE
TEXAS AND THE TRAILS, LLC, A TEXAS LIMITED LIABILITY COMPANY FOR
THE TRAILS AT WINDY HILL DEVELOPMENT**

THIS CONSENT AND DEVELOPMENT AGREEMENT (“*Agreement*”) is effective as set forth in Section 6.03 below, and is entered into by and between the City of Kyle, Texas, a Texas municipal corporation (“*City*”) and The Trails, LLC, a Texas limited liability company (“*Developer*”). City and Developer are sometimes referred to herein collectively as the “*Parties*” and individually as a “*Party*”. This Agreement supersedes any previous Consent and Development Agreement and/or Amendment to Consent and Development Agreement between City and any previous Developers. The Parties hereby agree as follows:

RECITALS

- A. WHEREAS, Developer is or will be the owner of approximately 244 acres of land, more or less, in Hays County, Texas, said 244 acre tract being more particularly described in **Exhibit A** attached hereto and made a part hereof for all purposes (the “*Developer Tract*”);
- B. WHEREAS, the Developer Tract is partially located within the extraterritorial jurisdiction (“*ETJ*”) of the City and the Developer will petition for the portion of the Developer Tract located outside the City’s ETJ, said portion being more particularly described in **Exhibit G** (the “*Out Parcel*”) to be annexed into the City’s ETJ as provided herein;
- C. WHEREAS, Developer has submitted to the City conceptual plans for the development of the Developer Tract, which will be known as the Trails at Windy Hill master planned subdivision (the “*Subdivision*”);
- D. WHEREAS, Developer desires to develop the Subdivision in accordance with the City's Comprehensive Plan and all applicable statutes, and ordinances, except as may be otherwise modified by the development standards established herein;
- E. WHEREAS, Developer desires for the Developer Tract to be annexed into that certain municipal utility district known as the North Hays County Municipal Utility District #1 (the “*District*”);
- F. WHEREAS, Developer will benefit from this Agreement by virtue of the City’s consent to the variance(s), accommodations and clarifications as more particularly described in this Agreement, as well as the annexation of the Developer Tract into the District, which will provide water, wastewater, drainage, solid waste and park facilities and services to the Subdivision;
- G. WHEREAS, City will benefit from this Agreement due to (i) the resulting development in accordance with its ordinances except as modified herein, and (ii) by the payment of the Master Development as provided herein;
- H. WHEREAS, Developer has created a Concept Plan attached hereto as **Exhibit B**.

NOW, THEREFORE, in exchange for the mutual promises and consideration herein expressed, other good and valuable consideration, the receipt and sufficiency of which are hereby acknowledged and confessed, and subject to the terms and conditions of this Agreement, the Parties agree as follows:

**ARTICLE I
DEVELOPMENT STANDARDS**

Section 1.01 Pursuant to Chapter 212.172, Loc. Gov't Code, City and Developer hereby agree as follows:

- (a) The Subdivision shall be developed in conformity with the zoning requirements specified as “R-1-A”: provided, however, that (i) ten percent (10%) of the residential lots therein shall be a minimum of sixty feet (60') by one hundred twenty feet (120'), being not less than 7,200 square feet (the “60’ Lots”), (ii) approximately fifty-one percent (51%) of the lots may be a minimum of fifty feet (50') by one hundred fifteen feet (115'), being not less than 5,750 square feet (the “50’ Lots”), and (iii) approximately thirty-nine percent (39%) of the lots may be a minimum of forty feet (40') by one hundred fifteen feet (115') being not less than 4,600 square feet (the “40’ Lots”, together with the 60’ Lots and the 50’ Lots being collectively referred to herein as the “Lots”), save and except, cul de sac Lots and Lots determined by the Planning and Zoning Commission to be uniquely shaped wherein the location of the lot creates a unique circumstance requiring minor deviations from the specific minimum dimensions.

- (b) The Developer agrees to create a homeowners association (“HOA”).

- (c) The Developer agrees that the City's Building Inspection Department will issue all permits and conduct all inspections to verify all structures meet minimum code requirements and that the City’s building codes and regulations will apply to construction of habitable structures on the Developer Tract in the same manner that such codes and regulations apply in the city limits. The City agrees to accept applications for up to 50 building permits for review and approval prior to the final subdivision acceptance of the initial phase of development; provided that Certificates of Occupancy will not be granted prior to the final subdivision acceptance of the initial phase of development unless the City is otherwise agreeable to granting said Certificates of Occupancy.

- (d) Notwithstanding the requirements specified for “R-1-A”, the following development authorizations are agreed upon between Developer and City and the Subdivision shall be developed in accordance with such development standards:
 - 1. The minimum square foot size for each single-family residence shall be increased by two hundred (200) square feet to a total of 1200 square feet.
 - 2. The minimum square foot size for garages shall be three hundred sixty (360) square feet.
 - 3. The garages need not be set back from the front wall of the house.

4. The building (residential and commercial) impervious coverage limitation for this provision shall be sixty-five percent (65%), and shall be measured/calculated on an “entire Project” basis (versus on a “per lot” basis). Developer and City shall fully cooperate in good faith to establish a reasonable mechanism to maintain a proper accounting for this method of auditing the foregoing. Developer will include 65% impervious cover in the declaration of covenants, conditions, and restrictions for the Subdivision (the “CC&Rs”).
5. The “R-1-A” setback zoning requirements for residences shall be as follows: (i) The 40’ Lots shall have a minimum of a twenty-five foot (25’) front yard setback, a five-foot (5’) side yard setback, and a fifteen-foot (15’) rear yard setback; (ii) the 50’ Lots shall have a minimum of a twenty foot (20’) front yard setback, a five-foot (5’) side yard setback, and a fifteen-foot (15’) rear yard setback; and (iii) the 60’ Lots shall have a minimum of a twenty foot (20’) front yard setback, a five-foot (5’) side yard setback, and a fifteen foot (15’) rear yard setback.
6. 40’ Lots, 50’ Lots, and 60’ Lots shall be interspersed on the same street as shown on **Exhibit B** attached hereto. Additionally, the Subdivision shall have fifteen foot (15’) wide open space lots permitting pedestrian ingress and egress to and from streets for the purposes of accessing other open space areas. The location of the 15’ open space “access” lots will be determined at the time of final platting.
7. All Lots may be front loaded, as opposed to being required to be loaded from the rear. All forward facing garages doors shall be clad in a neutral color and include architectural features such as windows and/or decorative handles.
8. Local streets shall have fifty feet (50’) of right-of-way with twenty-eight feet (28’) of pavement, in lieu of 60’ of right-of-way with 30’ of pavement.
9. Parking on one (1) side of local streets shall be permitted. Parking on the opposite side of such local street will be prohibited by two (2) “No Parking” signs with a decorative pole located at both ends of the local street. On local streets exceeding 500’ in length, a “No Parking” sign with a decorative pole shall be located at the approximate midpoint of such local street.
10. All light poles shall be decorative and also meet electricity provider’s standards for bulb, ballast and head maintenance.
11. Except as otherwise set forth below, all homes will feature exteriors of a masonry material on all four sides. This includes brick, natural stone, stucco, cementitious siding/panels, or other approved masonry cladding. Doors, windows, porch decking, and other architectural accent features are not required to be made from masonry materials. Notwithstanding the foregoing, all homes located on a corner Lot at the intersection of streets and all homes located immediately adjacent to and abutting Mathias Lane will not feature cementitious siding/panels on the facade of such homes facing or visible from such intersection and/or Mathias Lane.
12. Landscaping located within the public right-of-way is only required along the

primary collector street to and from Windy Hill Road and the private amenity center, said “*primary collector street*” being more particularly depicted on **Exhibit B** attached hereto.

13. Any other variance sought by Developer, not identified in this section or included in the variance table attached as **Exhibit C**, must comply with the City's variance process.
- (e) The City and Developer agree that the Developer Tract will not include more than 1,025 total Lots without the prior written consent of the City and will be in conformity with the percentages in subsection (a) of this Agreement. Provided, however, Developer may reduce the number and/or percentage of 40' Lots and increase the number and/or percentage of either the 50' Lots or the 60' Lots or both without amending this Agreement.

Section 1.02 Unless otherwise specifically modified or provided otherwise herein, all relevant codes, ordinances, regulations and applicable rules that apply within the City's ETJ shall apply to the Developer Tract and the Subdivision. If there is a direct conflict between the provisions of this Agreement and any codes, ordinances, regulations or applicable rules of the City, this Agreement while in effect shall control.

ARTICLE II OBLIGATIONS OF THE PARTIES

Section 2.01 Developer shall perform, or cause to be performed, each of the following:

- (a) Upon completion of Subdivision, Developer shall dedicate and convey to Hays County the respective streets and public rights-of-way as shown on the final plats; provided, however, that the fee simple title to any entry features, the HOA parks, and other similar common areas or public utility easement areas shall be conveyed by Developer to the District, HOA or other appropriate entity, which shall be and remain responsible for the upkeep and maintenance thereof.
- (b) If required as part of the Hays County Windy Hill Road widening improvements project, Developer shall dedicate by plat of the initial phase of the Subdivision, the right-of-way necessary for a right-turn lane into the Subdivision at its main entrance on Windy Hill Road, being more particularly depicted on **Exhibit D** attached hereto and incorporated herein.
- (c) Prior to receiving Certificates of Occupancy for the second phase of the Subdivision, Developer shall design and construct, at Developer's sole cost and expense, two fourteen foot (14') lanes of Mathias Lane with unpaved shoulders and bar ditches and a culvert (the “*Culvert*”) to be located at or near the existing low water crossing on Mathias Lane and, as more particularly shown on **Exhibit B** attached hereto. Said Culvert must be sufficient to eliminate stormwater from overtopping on Mathias Lane during a 100-year storm event with one vertical foot of freeboard, while allowing for upstream detention storage provided.
- (d) Developer shall comply with all relevant ordinances, which apply to the ETJ with the exception of the Variances contained in this Agreement and/or **Exhibit C**.

- (e) Developer shall submit plats to the City for approval, which shall not be unreasonably withheld, conditioned, or delayed.
- (f) Developer shall design drainage facilities to City's design standards;
- (g) Hays County will inspect and approve all phases of the construction of the Project's Street Facilities. Notwithstanding, the City has the right to inspect all phases of the construction of the Street Facilities; provided, however, that any such inspections shall be at the sole cost and expense of the City, unless Hays County transfers its right of inspection to the City in which case the expense will be borne by Developer.
- (h) Developer shall design and construct the water supply system to meet fire flow standards of the Goforth Special Utility District.
- (i) Curbs and gutters to be constructed on all streets in accordance with City's standards;
- (j) Developer shall dedicate up to twenty feet (20') of right-of-way for Windy Hill Road in the locations more particularly described and depicted on **Exhibit E** attached hereto and incorporated herein.
- (k) Developer shall dedicate, as necessary, a variable width right-of-way, as more particularly described and depicted on **Exhibit F** attached hereto and incorporated herein, allowing Mathias Lane to become an eighty foot (80') right-of-way measured from property line to property line on both sides of Mathias Lane. Notwithstanding anything herein to the contrary, Developer shall only be required to dedicate right-of-way along the portions and sides of Mathias Lane that are immediately adjacent to and abut the Subdivision. The Parties acknowledge that there are certain portions of Mathias Lane where the Subdivision abuts only one side of said right-of-way and in such instances, Developer shall only be required to dedicate its respective share of said right-of-way, that share being up to forty feet (40') to the centerline of Mathias Lane as it exists as of the date of this Agreement.
- (l) Developer shall construct perimeter fencing made of fencecrete along the rear of the Lots that abut and are immediately adjacent to Mathias Lane as shown on **Exhibit B** attached hereto and incorporated herein, and install six foot (6') wood privacy fencing along the remainder of the perimeter.
- (m) Developer shall provide City a copy of each utility bond issue application filed by the District with the Texas Commission of Environmental Quality ("**TCEQ**").
- (n) Developer agrees that the District debt issued will not cause the projected District ad valorem tax rate per TCEQ guidelines applicable to "projected growth" bond approvals to exceed applicable TCEQ guidelines.
- (o) Developer agrees that the land uses shown in the Concept Plan attached as **Exhibit B** will not be changed without the prior written approval of City. Provided, however, in order to provide flexibility with respect to certain details of the development of the Project, Developer may seek changes in the location and configuration of the use classifications

shown on the Concept Plan, including changes within the proposed residential, commercial, or open space areas shown on the Concept Plan as long as overall density does not exceed 1,025 Lots and/or the “mix” in Section 1.01(a) is not less than minimum percentage of 4,600 sq. ft. Lots. Such changes may be granted administratively by the City Manager or his designate.

- (p) Developer shall require that all front yards and side yards of corner Lots be irrigated and have landscape standards in compliance with the City’s requirements, which is enforced by the HOA and that trees or other landscape material that needs to be replaced from time to time be done so at the direction of the HOA in order to maintain a high standard of landscape throughout the neighborhood. Notwithstanding anything to the contrary contained herein, Developer shall not be required to place “Street Trees” within the rights-of-way. In lieu thereof, the front yards of each Lot shall contain one (1) “Street Tree” placed within the first five feet (5’) of the front yard of said Lot, as shown on **Exhibit B** attached hereto and labeled “Street Tree”.
- (q) Developer shall pay to the City the costs and expenses incurred by the City for the legal and engineering services related to this Agreement, the agreement with the District for annexation of the Developer Tract into the District, and the development of the Subdivision (except as otherwise set forth below) in accordance with applicable City ordinances; provided that such fees shall be the same as charged by the City to other similar developments in the City’s ETJ and may include without limitation, the Adjacent Lane Mile Fee, Parkland dedication fee (Land), and Parkland dedication fee (Improvements/Facilities). Such payment obligation shall not be applicable to engineering fees incurred with respect to the review and approval of plans and plats. Except as otherwise provided in this Agreement, Developer shall not be required to pay any additional contributions or fees, including without limitation, drainage fees or per lot developer contribution fees.
- (r) Developer shall pay to the City a Master Development Fee of \$2,000,000.00 to be paid to the City out of the net Developer reimbursement from the proceeds from the first issuance of bonds by the District for expenses related to the Trails at Windy Hill project. The City, the Developer and the District and any resulting district agree that the payment of the Master Development Fee is to be paid from the net Developer reimbursement from the proceeds of bonds issued by the District and any resulting district in conjunction with the closing of each such series of bonds, but in any event not later than 30 days from the date of closing on a series of bonds. The Developer shall enter such additional agreements with the District and the City as necessary to give effect to this subsection.

The parties recognize that the District must follow certain and precise steps to issue bonds, including obtaining the approval of the Texas Commission on Environmental Quality and the Office of the Attorney General. The parties agree to use good faith efforts to commence these steps on or before May 31, 2019 with the goal that these bonds be issued on or before December 31, 2019 (the “*Target Date*”). The parties acknowledge and agree that the Target Date is only a good faith goal and not a deadline since these factors are beyond the parties’ control.

If the bonds are issued after the Target Date, the parties agree that the City will receive the

first \$2,000,000.00 of net bond proceeds that the District issues related to the Trails of Windy Hill Project. Notwithstanding anything in this Agreement to the contrary, if the District does not issue the bonds at all, then in such event, the District and Developer shall have no liability to the City whatsoever.

The parties agree to memorialize the payment of the Master Development Fee by the Developer making a partial assignment of reimbursement rights in favor of the City by a separate agreement. This assignment shall be completed prior to or concurrent with the first issuance of District bonds related to the Trails at Windy Hill project.

- (s) The Developer shall, before conveying the drainage facilities to the District for ownership, maintenance, and operation, either: (i) cause the inspection of the drainage facilities for the Subdivision to be performed by a qualified third party inspector and a copy of such report provided to the City; or (ii) allow the City to inspect, at the City's expense, the drainage facilities to determine if the facilities were constructed in compliance with the applicable regulations and the approved construction plans. The Developer shall correct any defects in the drainage facilities identified during the inspection before conveying the drainage facilities to the District.
- (t) Within thirty (30) days of acquiring the Developer Tract, the Developer shall submit a written petition to the City in a form substantially similar to that set forth in Exhibit H requesting that the Out Parcel be annexed into the City's ETJ.

Section 2.02 City hereby agrees as follows:

- (a) City consents to the annexation of the Developer Tract into the District. Such consent to be made via separate resolution.
- (b) The District has and will exercise all powers permitted by Chapters 49 and 54, Texas Water Code or any other applicable statute.
- (c) City agrees to timely review Developer's preliminary plan, plat, construction plans, and any other documents and plans as may be necessary for the development of the Subdivision. City hereby agrees to the following:
 1. City shall have 40 business days to review and approve Developer's preliminary plan (the "*Preliminary Plan Review Period*"). The Preliminary Plan Review Period shall commence on that date which Developer first submits its preliminary plan to the City for review. The 40 business days comprising the Preliminary Plan Review Period shall be cumulative, but need not be consecutive. Therefore, if at any point during the Preliminary Plan Review Period, the City returns the preliminary plan back to Developer with comments, then said Preliminary Plan Review Period shall toll until that date that Developer re-submits the preliminary plan to the City for review, whereupon the Preliminary Plan Review Period shall re-commence. This review process shall continue until such time as the preliminary plan is final and approved by the City.
 2. Similar Section 2.02(c)1 above, City shall have 30 business days to review and approve Developer's plat and construction plans for the initial phase of the Subdivision (the

“*Plat & Construction Plan Review Period*”). The Plat & Construction Plan Review Period shall commence on that date which Developer first submits its plat and construction plans to the City for review. The 30 business days comprising the Plat & Construction Plan Review Period shall be cumulative, but need not be consecutive. Therefore, if at any point during the Plat & Construction Plan Review Period, the City returns both the plat and construction plans back to Developer with comments, then said Plat & Construction Plan Review Period shall toll until that date that Developer re-submits both the plat and construction plans to the City for review, whereupon the Plat & Construction Plan Review Period shall re-commence. This review process shall continue until such time as both the plat and constructions plans are final and approved by the City.

3. The Preliminary Plan Review Period and the Plat & Construction Plan Review Period may occur simultaneously.
4. If the City exceeds its permitted number of business days in either the Preliminary Plan Review Period or the Plat & Construction Plan Review Period, then, in such event, the Target Date shall be extended by one (1) business day (each, an “*Extension Day*”) for each one (1) business day of delay in either the Preliminary Plan Review Period or the Plat & Construction Plan Review Period. Extension Days shall be cumulative notwithstanding that the Preliminary Plan Review Period and the Plat & Construction Plan Review Period may run simultaneously. If the City exceeds its permitted number of business days in either the Preliminary Plan Review Period or the Plat & Construction Plan Review Period, the Developer shall not be excused from paying the City the Master Development Fee as set forth in Section 2.01(r) above, provided that there is a net Developer reimbursement from the proceeds of bonds issued by the District and any resulting district. The extension of the Target Date as provided in this paragraph shall be the Developer’s sole and exclusive remedy in the event the City exceeds its permitted number of business days in either the Preliminary Plan Review Period or the Plat & Construction Plan Review Period.

Section 2.03 The provisions of this Agreement shall be further evidenced by the following, as appropriate:

- (a) The execution and filing of an appropriate Memorandum of Record in the real property records of Hays County, Texas that includes explicit notice of the Developer’s agreement that the Developer Tract may be annexed into the City as provided in Section 4.01 of this Agreement and that such agreement is binding on persons who purchase property within the Developer Tract;
- (b) Appropriate notation(s) on the preliminary and final plats of the Subdivision; and
- (c) The execution and recording of a CC&Rs for the Subdivision, wherein the HOA will be funded for minimum maintenance requirements for property identified as HOA property within the Subdivision.

**ARTICLE III
ASSIGNMENT OF DEVELOPER RIGHTS AND OBLIGATIONS**

Section 3.01 Developer's rights and obligations under this Agreement may be assigned by Developer, and shall inure to the benefit of and be binding upon, future purchasers of all or part of the land within the Subdivision. Developer shall notify the City within five (5) working days of the completion of the Assignment.

ARTICLE IV ANNEXATION

Section 4.01 Developer approves this Agreement and shall be considered for all purposes a valid and legally sufficient request and petition by Developer, binding on successor owners of land in the District, to extend the city limits (i.e., incorporated municipal boundary) of the City to include the land in the Developer Tract within the City's municipal limits so long as such annexation is in compliance with the requirements below. No additional petitions from the Developer or any successor owners of land in the Developer Tract are necessary for annexation. Developer acknowledges and agrees that this annexation request can only be revoked by mutual agreement of Developer and the City.

Section 4.02 After 20 years from the effective date of this Agreement, the City shall have the right to annex any part of the Developer Tract if all supporting infrastructure has been completed to serve the developable acreage being annexed and the following conditions are met:

- (a) Developer has been fully reimbursed for the water, wastewater, and drainage facilities constructed or provided on behalf of the District and other reimbursable costs, including without limitation water impact fees reimbursable by the District, of serving the developable acreage within the Developer Tract that is subject to annexation in accordance with the Texas Water Code, any special legislation relating to the District, and the rules and standards of TCEQ or successor agency and Office of the Attorney General; and
- (b) The City assumes all obligations, debts and liabilities of the Developer Tract as provided by Chapter 43 of the Texas Local Government Code.

Upon review and satisfaction of these conditions to annexation, the City may, but will not be required to, annex the Developer Tract. The City agrees that the submission of a request for annexation will not be required in connection with the subdivision of any property located within the Developer Tract.

ARTICLE V MISCELLANEOUS PROVISIONS

Default

Section 5.01

- (a) If at any time either Party (the "*Defaulting Party*") shall have failed to duly perform any material obligations of this Agreement ("*Events of Default*"), the other Party (the "*Non-Defaulting Party*") may give written notice to the Defaulting Party specifying in reasonable detail the nature of the complaint ("*Notice of Complaint*"). If the Defaulting Party fails to cure the matter in a reasonable manner within thirty (30) days of the date of

receipt of such Notice of Complaint, or fails to take reasonable steps to secure and give reasonable assurances to the Non-Defaulting Party that such matter will be cured or rectified within a reasonable period of time and diligently pursues such cure to completion, then such failure to cure shall constitute a breach of this Agreement. Upon a breach of this Agreement, the non-defaulting Party, in any court of competent jurisdiction, by an action or proceeding at law or in equity, may pursue any remedy available at law or at equity. Except as otherwise set forth herein, no action taken by a Party pursuant to the provisions of this Section or pursuant to the provisions of any other Section of this Agreement shall be deemed to constitute an election of remedies; and all remedies set forth in this Agreement shall be cumulative and non-exclusive of any other remedy either set forth herein or available to any Party at law or in equity. Each of the Parties shall have the affirmative obligation to mitigate its damages in the event of a default by the other Party. The Developer may only terminate this Agreement if the City fails to enter into an agreement with District and consent to the annexation of the Developer Tract into the boundaries of the District by delivering written notice to the Developer stating that this Agreement is terminated (“*Notice of Termination*”). Such termination shall be effective as and from the day which is specified in the Notice of Termination. Notwithstanding anything herein to the contrary, no Party shall be deemed to be in default hereunder until the passage of the notice and cure periods set forth in this Section 5.01.

- (b) No public official or employee shall be personally responsible for any liability arising under or growing out of this Agreement.
- (c) The City shall not be liable for consequential damages, specifically lost profits, and any damages claimed against the City shall be limited to amounts recoverable under §271.153 of the Texas Local Government Code, to the extent damages may be recoverable under applicable law. The parties agree that this Agreement shall not be interpreted as or otherwise claimed to be a waiver of governmental immunity on the part of the City.

Force Majeure

Section 5.02 The term “*force majeure*” as used herein shall mean and refer to Acts of God, strikes, lockouts, or other industrial disturbances, acts of public enemies, orders of any kind of the government of the United States, the State of Texas or any civil or military authority, insurrections, riots, epidemics, landslides, lightning, earthquake, fire, hurricanes, storms, floods, washouts, droughts, arrests, restraint of government and people, disturbances, explosions, breakage or accidents to machinery, pipelines, or canals, or other causes not reasonably within the control of the party claiming such inability.

Section 5.03 If, by reason of force majeure, any Party hereto shall be rendered wholly or partially unable to carry out its obligations under this Agreement, then such Party shall give written notice of the full particulars of such force majeure to the other party within ten (10) days after the occurrence thereof. The obligations of the Party giving such notice, to the extent effected by the force majeure, shall be suspended during the continuance of the inability claimed, except as hereinafter provided, and the Party shall endeavor to remove or overcome such inability with all reasonable dispatch.

Notices

Section 5.04 All notices, demands and requests required hereunder shall be in writing and shall be deemed to have been properly delivered and received (i) as of the date of delivery to the addresses set forth below if personally delivered or delivered by facsimile machine, with confirmation of delivery (in the event a facsimile is sent after 5:00 p.m. local Austin, Texas time, it shall be deemed to have been received on the next day), or email (as indicated below); (ii) three (3) business days after deposit in a regularly maintained receptacle for the United States mail, certified mail, return receipt requested and postage prepaid; or (iii) one (1) business day after deposit with Federal Express or comparable overnight delivery system for overnight delivery with all costs prepaid. All notices, demands and requests hereunder shall be addressed as follows:

If to City: City of Kyle
Attn: City Manager
100 W. Center Street
Kyle, Texas 78640

If to the Developer: The Trails, LLC
Attn: Doug Moss
9100 Calera Drive, Unit 10
Austin, Texas 78735-1576

Mr. Charles Holbrook
10 Rainey St., No. 2502
Austin, Texas 78701

With copy to: Mr. Andrew N. Barrett
Andy Barrett & Associates
711 W. 7th Street
Austin, Texas 78701

Any party may change the address for notice to it by giving notice of such change in accordance with the provisions of this Section.

**ARTICLE VI.
MISCELLANEOUS PROVISIONS**

Term

Section 6.01 This Agreement shall be effective for thirty-five (35) years from the Effective Date and an automatic extension of 10 years, provided that the Agreement is not earlier terminated in accordance with the terms, provisions and conditions of this Agreement.

Entire Agreement

Section 6.02 This Agreement, together with any exhibits attached hereto, constitutes the entire agreement between the Parties hereto, and may not be amended except by a writing signed by all parties and dated subsequent to the date hereof. Provided, further, that this Agreement supersedes any previous development and consent agreements and any amendments thereto.

Effective Date

Section 6.03 “*Effective Date*” means the date the Agreement is fully executed by all parties.

Texas Law Governs

Section 6.04 This Agreement shall be governed by and construed in accordance with the laws of the State of Texas and shall be performable in Hays County, Texas. Venue shall be exclusively in Hays County, Texas.

Time of the Essence

Section 6.05 It is acknowledged and agreed by the Parties that time is of the essence in the performance of this Agreement.

Execution

Section 6.06 This Agreement may be executed in one or more counterparts, each of which shall be deemed an original, but all of which together shall constitute one and the same instrument. The Parties agree that facsimile signatures sent to each respective Party solely for the purpose of evidencing each Party's execution of this Agreement shall be acceptable to bind the Parties and shall not in any way affect this Agreement's validity. The Parties intend to confirm the initial facsimile signatures by exchanging ink-signed originals, but the Parties' failure to exchange ink-signed originals shall not affect the Agreement's validity in any way.

Joinder and Consent

Section 6.07 Developer and D. E. and Nova Crumley Family Limited Partnership, a Texas limited partnership (“*Crumley FLP*”) have entered into that certain Unimproved Property Contract dated July 15, 2016 (as may be amended, the “*Crumley FLP Contract*”) pursuant to which Developer has the contractual right to purchase the Developer Tract. The Developer Tract will be purchased in up to five separate closings, as more fully set forth in the Crumley FLP Contract. The City and Developer acknowledge and agree that the ability of Developer to perform its obligations set out in this Agreement is contingent on Developer closing on the Crumley FLP Contract according to its terms and conditions. Accordingly, Crumley FLP, as fee simple owner of all or a portion of the Developer Tract subject to the contractual right set forth herein above, does hereby join and consent to this Agreement and to the imposition of said Agreement on the Developer Tract.

Anti-Boycott Verification

Section 6.08 To the extent this Agreement constitute a contract for goods or services within the meaning of Section 2270.002 of the Texas Government Code, as amended, solely for purposes of compliance with Chapter 2270 of the Texas Government Code, and subject to applicable Federal law, Developer represents that neither Developer nor any wholly owned subsidiary, majority-owned subsidiary, parent company or affiliate of Developer (i) boycotts Israel or (ii) will boycott Israel through the term of this Amendment or the Agreement. The terms “boycotts Israel” and “boycott Israel” as used in this paragraph have the meanings assigned to the term “boycott Israel” in Section

808.001 of the Texas Government Code, as amended.

Iran, Sudan and Foreign Terrorist Organizations

Section 6.09 To the extent this Agreement constitute a governmental contract within the meaning of Section 2252.151 of the Texas Government Code, as amended, solely for purposes of compliance with Chapter 2252 of the Texas Government Code, and except to the extent otherwise required by applicable federal law, Developer represents that neither Developer nor any wholly owned subsidiary, majority-owned subsidiary, parent company or affiliate of Developer is a company listed by the Texas Comptroller of Public Accounts under Sections 2270.0201, or 2252.153 of the Texas Government Code.

[Remainder of this page intentionally left blank]

IN WITNESS WHEREOF, the Parties have executed this Agreement as of the date the last signature is affixed hereto below.

CITY:

City of Kyle, Texas
(a municipal corporation)

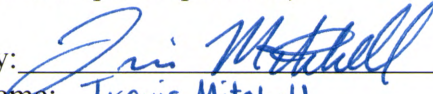
By: 
Name: Travis Mitchell
Title: Mayor

Date: June 28, 2018

DEVELOPER:

The Trails, LLC
(a Texas limited liability company)

By: 
Name: DOUGLAS G. MOSS
Title: PARTNER

Date: 8-7-18, 2018

Acknowledgement and Acceptance:

D. E. and Nova Crumley Family Limited Partnership
(a Texas limited partnership)

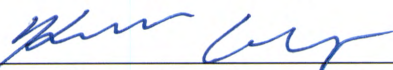
By: 
Name: KEVIN CRUMLEY
Title: POWER OF ATTORNEY

Date: 8-16-18, 2018

EXHIBIT A
DEVELOPER TRACT

[See Attached]

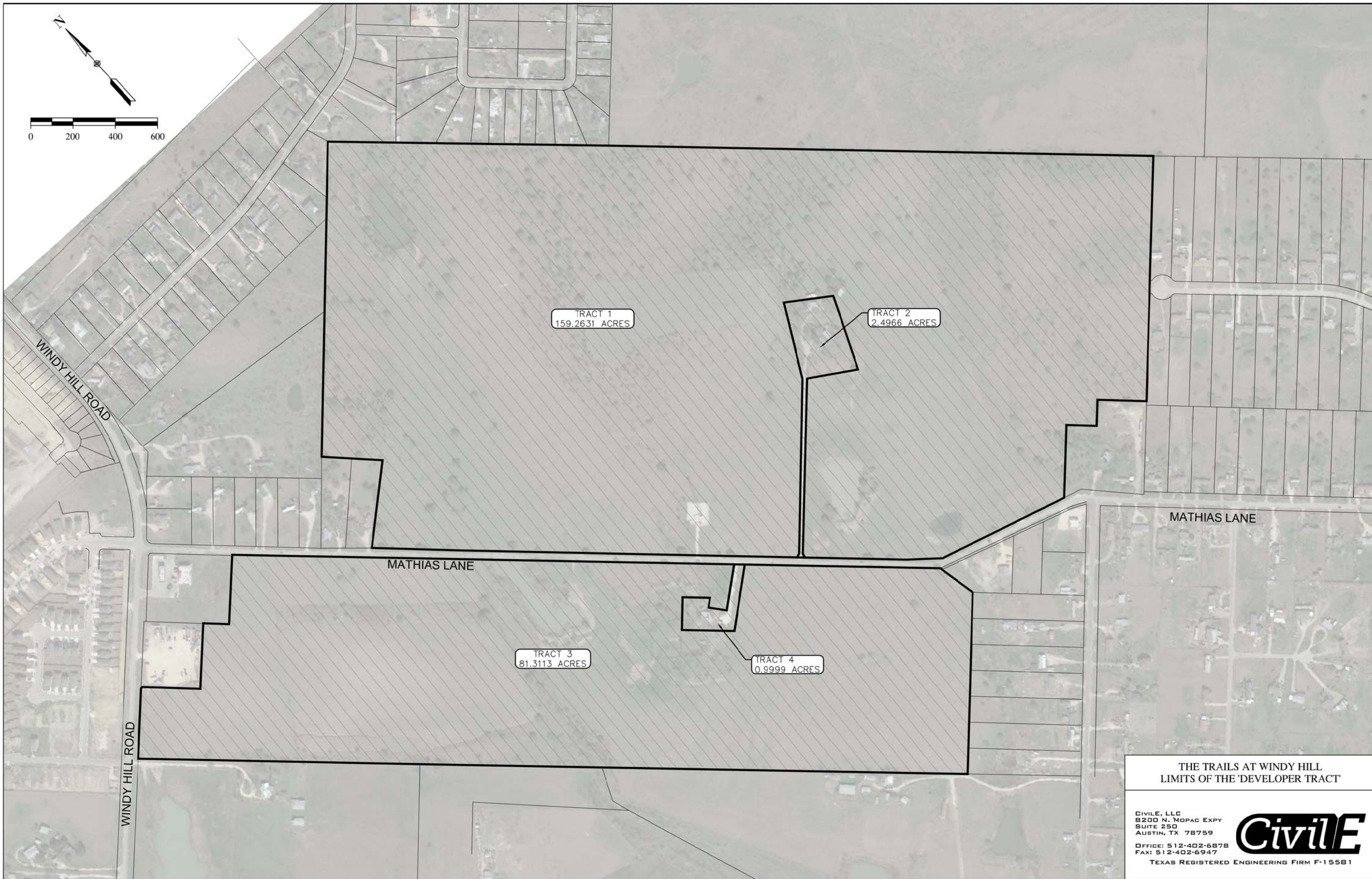
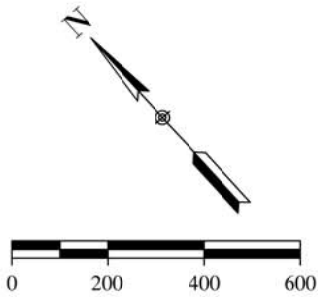

TRACT 1
159.2631 ACRES

TRACT 2
2.4966 ACRES

TRACT 3
81.3113 ACRES

TRACT 4
0.9999 ACRES

MATHIAS LANE

MATHIAS LANE

WINDY HILL ROAD

WINDY HILL ROAD

THE TRAILS AT WINDY HILL
LIMITS OF THE 'DEVELOPER TRACT'

CIVILE, LLC
8200 N. MOPAC EXPY
SUITE 250
AUSTIN, TX 78759
OFFICE: 512-402-6878
FAX: 512-402-6947



TEXAS REGISTERED ENGINEERING FIRM F-15581

F:\17000a\17011_Windy_Hill\CAD\GIS\17011_Development_Agreement\17011_Development_Agreement_EC_Conditions.dwg
ecarter
2017.09.27 02:40 PM

STATE OF TEXAS §
 §
COUNTY OF HAYS §

FIELDNOTE DESCRIPTION of a 159.2631 acre tract out of the Jonathan Williams Survey, Abstract No. 538 and the Z. Hinton Survey No. 4, Abstract No. 219 in Hays County, Texas, being the remainder of that 161.170 acre tract, described as Exhibit A, as conveyed to D. E. and Nova Crumley Family Limited Partnership by deed recorded in Volume 1508, Page 697 of the Official Public Records of Hays County, Texas; the said 159.2631 acre tract is more particularly described by metes and bounds as follows:

BEGINNING at a ½” iron rod, with plastic cap marked “Capital Surveying Company, Inc.”, found in a 26 inch Hackberry tree, on the existing northeast right-of-way line of Mathias Lane (County Road 129), for the most westerly corner of the said 161.170 acre tract, same being the most southerly corner of that 1.293 acre tract, described as Tract 2, conveyed to Crumley Rental Properties, Inc. by deed recorded in Volume 1508, Page 705 of the said Official Public Records, from which a ½” iron rod, without cap, found on the northerly right-of-way line of Mathias Lane, for the most westerly corner of that 1.293 acre tract, described as Tract 1, conveyed to Crumley Rental Properties, Inc. by deed recorded in Volume 1508, Page 708 of the said Official Public Records, bears N48°21’00”W, 240.88 feet;

THENCE, leaving the northeast right-of-way line of Mathias Lane, with the common line between the said 161.170 acre tract, the said 1.293 acre tract (Tract 2) and the 1.293 acre tract (Tract 1), for the following two (2) courses:

- 1) N48°57’57”E, 418.05 feet to a ½” iron rod, without cap, found for corner;
- 2) N44°44’11”W, 288.91 feet to a ½” iron rod, without cap, found for the most northerly corner of the aforesaid 1.293 acre tract (Tract 1), being on the easterly line of Lot 1, Block 4, Rolling Hills Estates, Section 1, a subdivision recorded in Book 1, Page 213 of the Plat Records of Hays County, Texas;

THENCE, N43°08’09”E, leaving the northeast line of the said 1.293 acre tract (Tract 1), with the northwest line of the 161.170 acre tract and southeast line of Rolling Hills Estates, Section 1, subdivision, at 1128.42 feet pass a ½” iron rod, without cap, found 1.1 feet to the right, at 1226.59 feet pass a ½” iron rod, without cap, found on line, for a total distance of 1490.79 feet to a calculated point for the most northerly corner of the herein described tract, same being the most northerly corner of the aforesaid 161.170 acre tract and an ell corner on the southerly line of aforesaid Rolling Hills Estates, Section 1, subdivision, from which a fence post found, bears N43°08’09”E, 0.68 feet;

THENCE, S47°11'31"E, with the northeast line of the said 161.170 acre tract, at a distance of 0.45 feet pass a ½" iron rod, without cap, found 1.28 feet to the right, at a calculated distance of 346.50 feet pass the southeast corner of aforesaid Rolling Hills Estates, Section 1, subdivision, being the most westerly corner of Rolling Hills Estates, Section 2, a subdivision recorded in Book 1, Page 215 of the said Plat Records, and continuing with the southwest line of said Rolling Hills Estates, Section 2, subdivision, at a distance of 760.67 feet pass a ½" iron rod, without cap, found 0.9 feet to the right, at a distance of 835.31 feet pass a ½" iron rod, without cap, found on line, at a distance of 909.51 feet pass a ½" iron rod, without cap, found 1.3 feet to the left, for a total distance of 1331.48 feet to a ½" iron rod, without cap, found for the most southerly corner of aforesaid Rolling Hills Estates, Section 2, subdivision, same being the most westerly corner of that 190.258 acre tract, described as Tract 3, conveyed to Studio Estates, LLC, by deed recorded in Volume 5063, Page 491 of the said Official Public Records;

THENCE, S46°54'58"E, leaving the southeast line of said Rolling Hills Estates, Section 2, with the northeast line of the said 161.170 acre tract, being the southwest line of the 190.258 acre tract, for a distance of 2577.55 feet to a 1/2" iron rod, with plastic cap marked "Capital Surveying Company, Inc.", found for the most easterly corner of the herein described tract, same being the most easterly corner of the 161.170 acre tract and the most northerly corner of Meadow Vista, Section 2, a subdivision recorded in Book 11, Page 85 of the said Plat Records;

THENCE, S43°37'40"W, leaving the southwest line of the said 190.258 acre tract, with the common southeast line of the 161.170 acre tract and northwest line of Meadow Vista, Section 2, subdivision, 1160.59 feet to a ½" iron rod, with plastic cap marked "Carson and Bush", found for the most easterly corner of Foster Place, Section Two, a subdivision recorded in Book 12, Page 176 of the said Plat Records, from which a ½" iron rod, with plastic cap marked "Carson and Bush", found for the most westerly corner of aforesaid Meadow Vista, Section 2, subdivision, being the most northerly corner of Meadow Vista, Section 1, a subdivision recorded in Book 9, Page 40 of the said Plat Records and a point on the southeast line of said Foster Place, Section Two, subdivision, bears S43°01'20"W, 18.77 feet;

THENCE, leaving the northwest line of said Meadow Vista, Section 2, subdivision, across the said 161.170 acre tract, with the northerly line of said Foster Place, Section Two, subdivision, for the following two (2) courses:

- 1) N46°25'05"W, 231.26 feet to a ½" iron rod, with plastic cap marked "Carson and Bush", found for corner;
- 2) S43°46'50"W, 123.48 feet to a ½" iron rod, with plastic cap marked "Capital Surveying Company, Inc.", found for corner, from which a ½" iron rod, with plastic cap marked "Carson and Bush, found for an angle point on the aforesaid Foster Place, Section Two, subdivision bears S43°46'50"W, 47.25 feet;

THENCE, leaving the northwest line of Foster Place, Section Two, subdivision and continuing across the said 161.170 acre tract, for the following two (2) courses:

- 1) N46°13'10"W, 143.00 feet to a ½" iron rod, with plastic cap marked "Capital Surveying Company, Inc.", found for corner;

- 2) S43°46'50"W, 344.19 feet to a ½" iron rod, with plastic cap marked "Capital Surveying Company, Inc.", found on the southwest line of the aforesaid 161.170 acre tract, same being the northeast right-of-way line of existing Mathias Lane, from which a 60d nail found in a fence corner post on the common northeast right-of-way line of said Mathias Lane and southwest line off the 161.170 acre tract, same being the most westerly corner of that 1.143 acre tract conveyed to Crumley Rental Properties, Inc. by deed recorded in Volume 1508, Page 712 of the said Official Public Records, bears S74°25'34"E, 90.15 feet;

THENCE, with the common southwest line of the 161.170 acre tract and northeast right-of-way line of Mathias Lane, for the following three (3) courses:

- 1) N74°25'34"W, 643.34 feet to a ½" iron rod, with plastic cap marked "Capital Surveying Company, Inc., found for corner;
- 2) N50°14'21"W, 169.42 feet to a ½" iron rod, with plastic cap marked "Capital Surveying Company, Inc., found for corner;
- 3) N46°50'00"W, 481.98 feet to a ½" iron rod, with plastic cap marked "Capital Surveying Company, Inc., found for the most westerly southwest remainder corner of that 100 acre tract, described as Tract I, conveyed to D.E. Crumley by deed recorded in Volume 208, Page 354 of the Deed Records of Hays County, Texas and the remainder of that 100.00 acre tract as conveyed to D.E. Crumley by deed recoded in Volume 372, Page 318 of the said Deed Records and as further described in in Volume 155, Page 532 of the said Deed Records;

THENCE, leaving the northeast right-of-way line of Mathias Lane, with the common line between the said 161.107 acre tract and the remainder of the 100 acre tract (Tract I) and 100.00 acre tract, for the following eight (8) courses:

- 1) N11°47'53"E, 20.48 feet to a ½" iron rod, with plastic cap marked "Capital Surveying Company, Inc., set for corner;
- 2) N43°22'40"E, 829.17 feet to a ½" iron rod found, without cap, for corner;
- 3) S58°05'43"E, 245.47 feet to a ½" iron rod found, without cap, for corner;
- 4) N23°20'06"E, 367.35 feet to a ½" iron rod found, without cap, for corner;
- 5) N55°40'29"W, 236.32 feet to a ½" iron rod found, without cap, for corner;
- 6) S28°15'03"W, 373.10 feet to a ½" iron rod found, without cap, for corner;
- 7) S43°04'12"W, 826.33 feet to a ½" iron rod found, without cap, for corner;
- 8) S76°52'04"W, 20.56 feet to a ½" iron rod found, without cap, for the most westerly northwest corner of the aforesaid remainder of the 100 acre tract (Tract I), same being a point on the northeast right-of-way line of aforesaid Mathias Lane;

THENCE, with the common southwest line of the 161.170 acre tract and northeast right-of-way line of Mathias Lane, for the following two (2) courses:

- 1) N46°48'47"W, 1577.63 feet to a ½" iron rod, with plastic cap marked "Capital Surveying Company, Inc.", found for corner;
- 2) N46°24'06"W, for a distance of 435.26 feet to the POINT OF BEGINNING, CONTAINING within these metes and bounds 159.2631 acres of land area.

Basis of Bearing is the Texas State Plane Coordinate System, South Central Zone, NAD83 (Grid).

I, Gregory A. Way, a Registered Professional Land Surveyor, do hereby certify that the above description is true and correct to the best of my knowledge and that the property described herein was determined by a survey made on the ground under my direction and supervision.

WITNESS MY HAND AND SEAL at Austin, Travis County, Texas, this the 12th day of June, 2017.





GREGORY A. WAY
Registered Professional Land Surveyor
No. 4567 State of Texas

STATE OF TEXAS §
 §
COUNTY OF HAYS §

FIELDNOTE DESCRIPTION of a 2.4966 acre tract out of the Jonathan Williams Survey, Abstract No. 538 and the Z. Hinton Survey No. 4, Abstract No. 219 in Hays County, Texas, being a remainder portion of that 100 acre tract, described as Tract I, as conveyed to D. E. Crumley, by deed recorded in Volume 208, Page 354 of the Deed Records of Hays County, Texas and that 100.00 acre tract as conveyed to D. E. Crumley by deed recorded in Volume 372, Page 318 of the said Deed Records, and as described in Volume 155, Page 532 of the said Deed Records; the said 2.4966 acre tract is more particularly described by metes and bounds as follows:

COMMENCING at a ½" iron rod, with plastic cap marked "Capital Surveying Co., Inc.", found in a 26 inch Hackberry tree, on the existing northeast right-of-way line of Mathias Lane (County Road 129), for the most westerly corner of that 161.170 acre tract, as conveyed to the D.E. and Nova Crumley Family Limited Partnership by deed recorded in Volume 1508, Page 697 of the Official Public Records of Hays County, Texas, same being the most southerly corner of that 1.293 acre tract, described as Tract 2, as conveyed to Crumley Rental Properties, Inc., by the deed recorded in Volume 1508, Page 705 of the said Official Public Records, from which a ½" iron rod, without cap, found on the northeast right-of-way line of Mathias Lane, for the most westerly corner of that 1.293 acre tract conveyed to Crumley Rental Properties, Inc., by deed recorded in Volume 1508, Page 708 of the said Official Public Records, bears N48°21'00"W, 240.88 feet;

THENCE, leaving the southwest line of the said 1.293 acre tract, with the common northeast right-of-way line of Mathias Lane and the southwest line of the said 161.170 acre tract, for the following two (2) courses:

- 1) S46°24'06"E, 435.26 feet to a ½" iron , with plastic cap marked "Capital Surveying Co., Inc.", found;
- 2) S46°48'47"E, 1577.63 feet to a ½" iron rod, without cap, found for the southwest corner and POINT OF BEGINNING of the herein described tract;

THENCE, leaving the northeast right-of-way line of Mathias Lane, with the perimeter line of the said 161.170 acre tract, being the said remainder line of the 100 acre tract (Tract I), and the said 100.00 acre tract, for the following eight (8) courses:

- 1) N76°52'04"E, 20.56 feet to a ½" iron rod found, without cap, for corner;
- 2) N43°04'12"E, 826.33 feet to a ½" iron rod found, without cap, for corner;
- 3) N28°15'03"E, 373.10 feet to a ½" iron rod found, without cap, for the most northerly corner of the herein described tract;
- 4) S55°40'29"E, 236.32 feet to a ½" iron rod found, without cap, for the most easterly corner of the herein described tract;

- 5) S23°20'06"W, 367.35 feet to a ½" iron rod found, without cap, for corner;
- 6) N58°05'43"W, 245.47 feet to a ½" iron rod found, without cap, for corner;
- 7) S43°22'40"W, 829.17 feet to a ½" iron rod, with plastic cap marked "Capital Surveying Co., Inc.", found for corner;
- 8) S11°47'53"W, 20.48 feet to a ½" iron rod, with plastic cap marked "Capital Surveying Co., Inc.", found on the aforesaid northeast right-of-way line of Mathias Lane (County Road 129), the southeast corner of the herein described tract and an ell corner of the aforesaid 161.170 acre tract;

THENCE, N47°01'35"W, leaving the said 161.170 acre tract, with the common southerly remainder line of the said 100 acre tract (Tract I) and northeast right-of-way line of Mathias Lane, for a distance of 38.98 feet to the POINT OF BEGINNING, CONTAINING within these metes and bounds 2.4966 acres of land area.

Basis of Bearing is the Texas State Plane Coordinate System, South Central Zone, NAD83 (Grid).

I, Gregory A. Way, a Registered Professional Land Surveyor, do hereby certify that the above description is true and correct to the best of my knowledge and that the property described herein was determined by a survey made on the ground under my direction and supervision.

WITNESS MY HAND AND SEAL at Austin, Travis County, Texas, this the 12th day of June, 2017.





GREGORY A. WAY
Registered Professional Land Surveyor
No. 4567 State of Texas

STATE OF TEXAS §
 §
COUNTY OF HAYS §

FIELDNOTE DESCRIPTION of a 81.3113 acre tract out of the Samuel Little Survey No. 8, Abstract No. 286 in Hays County, Texas, being a portion of that 100.467 acre tract, described as Exhibit B, as conveyed to D. E. and Nova Crumley Family Limited Partnership by deed recorded in Volume 1508, Page 697 of the Official Public Records of Hays County, Texas; the said 81.3113 acre tract is more particularly described by metes and bounds as follows:

BEGINNING at a ½” iron rod found, with plastic cap marked “Bush”, for an angle point on the northeast line of the aforesaid 100.467 acre tract, being on the southwest right-of-way line of Mathias Lane (County Road 129 – right-of-way varies) and the northwest corner of Foster Place, Section Three, a subdivision recorded in Book 18, Page 68 of the Plat Records of Hays County, Texas;

THENCE, S11°29’01”E, leaving the southwest right-of-way line of Mathias Lane, across the said 100.467 acre tract, with the westerly line of Foster Place, Section Three subdivision, for a distance of 191.92 feet to a ½” iron rod, with cap marked “Capital Surveying Company, Inc.”, found for the southwest corner of aforesaid Foster Place, Section Three, being the most northerly corner of Foster Place, a subdivision recorded in Book 10, Page 103 of the said Plat Records;

THENCE, S43°37’45”W, continuing across the said 100.467 acre tract, with the northwest line of Foster Place subdivision, for a distance of 859.52 feet to a ½” iron rod, with cap marked “Capital Surveying Company, Inc.”, found for the southwest corner of aforesaid Foster Place subdivision, being on the southwest line of the aforesaid 100.467 acre tract and a point on the northeast line of that 25.44 acre tract conveyed to Nastassja Ladden by deed recoded in Volume 4572, Page 828 of the said Official Public Records, from which a ½” iron rod found, without cap, for the most southerly corner of aforesaid Foster Place subdivision, being the most easterly corner of the said 25.44 acre tract and a point on the northwest right-of-way line of Foster Place Road (County Road 125), bears S46°58’36”E, 537.61 feet;

THENCE, N46°58’36”W, leaving the northwest line of Foster Place subdivision, with the southerly line of the said 100.467 acre tract, at a distance of 1731.22 feet pass a ½” iron rod found, without cap, 0.69 feet to the left for the most northerly corner of the aforesaid 25.44 acre tract, being a southeast corner of that 12.565 acre tract conveyed to Lozell L. Logan and Mary C. Logan by deed recorded in Volume 303, Page 388 of the Deed Records of Hays County, Texas, and continuing for a total distance of 2593.69 feet to a ½” iron rod, without cap, found for the most northerly corner of the said 12.565 acre tract, being the most easterly corner of that 22.00 acre tract conveyed to Lozell L. Logan and Mary C. Logan by deed recorded in Volume 233, Page 283 of the said Deed Records;

THENCE, N46°52’08”W, leaving the northerly line of the said 12.565 acre tract, with the common southwest line of the 100.467 acre tract and northeast line of the 22.00 acre tract, for a distance of 1333.83 feet to a ½” iron rod, with cap marked “Capital Surveying Company, Inc.”, found for the most westerly corner of the aforesaid 100.467 acre tract, being on the easterly right-of-way line of Windy Hill Road (County Road 131 – right-of-way varies);

THENCE, N44°23'29"E, leaving the northerly line of the said 22.00 acre tract, with the common northwest line of 100.467 acre tract and southeast right-of-way line of Windy Hill Road, same being the southeast line of that 0.328 acre tract conveyed for additional right-of-way in Volume 1149, Page 410 of the said Official Public Records, for a distance of 339.61 feet to a fence corner post found, for the most westerly corner of that 2.00 acre tract conveyed to Renan Cevallos by deed recorded in Document No. 2014-14001965 of the said Official Public Records;

THENCE, leaving the easterly right-of-way line of Windy Hill Road and crossing through the said 100.467 acre tract, with the southwest and southeast lines of the said 2.00 acre tract, for the following two (2) courses:

- 1) S46°12'24"E, 280.88 feet to a ½" iron rod, with cap marked "Hayes RPLS 5703", found;
- 2) N44°25'43"E, 310.00 feet to a ½" iron rod, with cap marked "Hayes RPLS 5703", found on for the most easterly corner of the said 2.00 acre tract, being on the southwest line of Lot 1, Kyle Project, LLC, a subdivision recorded in Book 16, Page 323 of the said Plat Records;

THENCE, S46°12'24"E, leaving the easterly line of the said 2.00 acre tract and continuing across the said 100.467 acre tract, with the southwest line of said Lot 1, for a distance of 122.77 feet to a ½" iron rod, with plastic cap marked "4160.", found for the most southerly corner of aforesaid Lot 1;

THENCE, N44°32'17"E, continuing across the said 100.467 acre tract, with the southeast line of said Lot 1, at a distance of 324.25 feet pass a ½" iron rod, with plastic cap marked "4160", found for the most easterly corner of aforesaid Lot 1 and continuing for a total distance of 328.14 feet to a ½" iron rod, with marked "Capital Surveying Company, Inc.", found for the most northerly corner of the herein described tract, same being a point on the common northeast line of the aforesaid 100.467 acre tract and southwest right-of-way line of Mathias Drive;

THENCE, S46°54'53"E, with the common southwest right-of-way line of Mathias Drive and northeast line of the said 100.467 acre tract, 2376.26 feet to a calculated angle point on the northeast line of the said 100.467 acre tract, being the most northerly corner of that 1.00 acre tract conveyed to Crumley Rental Properties, Inc. by deed recorded in Volume 1508, Page 715 of the said Official Public Records;

THENCE, leaving the southwest right-of-way line of Mathias Lane, with the common line between the said 100.467 acre tract and 1.00 acre tract, for the following seven (7) courses:

- 1) S50°49'45"W, 220.48 feet to a cotton gin spindle found for corner;
- 2) N39°00'44"W, 87.63 feet to a ½" iron rod found, without cap, for corner;
- 3) N50°05'51"E, 46.57 feet to a calculated point for corner;
- 4) N46°53'55"W, 130.19 feet to a calculated point for corner;
- 5) S43°05'05"W, 154.98 feet to a calculated point for corner, from which a ½" iron rod found, without cap, bears S50°25'57"W, 1.88 feet;
- 6) S46°54'55"E, 248.29 feet to a ½" iron rod found, without cap, for the most southerly corner of the aforesaid 1.00 acre tract;

- 7) N50°53'16"E, 318.09 feet to a calculated point for the northeast corner of the aforesaid 1.00 acre tract, being a northerly corner of the 100.467 acre tract and a point on the southwest right-of-way line of Mathias Lane;

THENCE, S46°54'53"E, leaving the easterly line of the said 1.00 acre tract, with the common northeast line of the said 100.467 acre tract and southwest right-of-way line of Mathias Lane, for a distance of 925.62 feet to the POINT OF BEGINNING, CONTAINING within these metes and bounds 81.3113 acres of land area.

Basis of Bearing is the Texas State Plane Coordinate System, South Central Zone, NAD83 (Grid).

I, Gregory A. Way, a Registered Professional Land Surveyor, do hereby certify that the above description is true and correct to the best of my knowledge and that the property described herein was determined by a survey made on the ground under my direction and supervision.

WITNESS MY HAND AND SEAL at Austin, Travis County, Texas, this the 12th day of June, 2017.



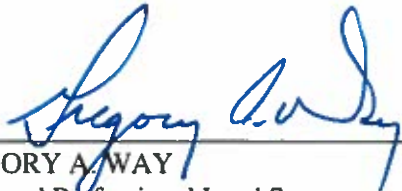

GREGORY A. WAY
Registered Professional Land Surveyor
No. 4567 State of Texas

STATE OF TEXAS §
 §
COUNTY OF HAYS §

FIELDNOTE DESCRIPTION of a 0.9999 acre tract out of the Samuel Little Survey No. 8, Abstract No. 286 in Hays County, Texas, being all of that 1.00 acre tract as conveyed to Crumley Rental Properties Inc. by deed recorded in Volume 1508, Page 715 of the Official Public Records of Hays County, Texas; the said 0.9999 acre tract is more particularly described by metes and bounds as follows:

COMMENCING at a ½" iron rod found, with plastic cap marked "Bush", for an angle point on the northeast line of the that 100.467 acre tract conveyed to D. E. and Nova Crumley Family Limited Partnership by deed recorded in Volume 1508, Page 697 of the said Official Public Records, being on the southwest right-of-way line of Mathias Lane (County Road 129 – right-of-way varies) and the northwest corner of Foster Place, Section Three, a subdivision recorded in Book 18, Page 68 of the Plat Records of Hays County, Texas, from which a ½" iron rod found, with cap marked "Bush", on the common north line of said Foster Place, Section Three and the south right-of-way line of Mathias Lane, bears S73°14'25"E, 689.07 feet;

THENCE, N46°54'53"W, leaving the westerly line of said Foster Place, Section Three subdivision, with the common southwest right-of-way line of Mathias Lane and northeast line of the said 100.467 acre tract, for a distance of 925.62 feet to a calculated point for the northeast corner and POINT OF BEGINNING of the herein described tract;

THENCE, leaving the southwest right-of-way line of Mathias Lane, with the common line between the said 100.467 acre tract and 1.00 acre tract, for the following seven (7) courses:

- 1) S50°53'16"W, 318.09 feet to a ½" iron rod found, without cap, for corner;
- 2) N46°54'55"W, 248.29 feet to a calculated point for corner, from which a ½" iron rod found, without cap, bears S50°25'57"W, 1.88 feet;
- 3) N43°05'05"E, 154.98 feet to a calculated point for corner;
- 4) S46°53'55"E, 130.19 feet to a calculated point for corner;
- 5) S50°05'51"W, 46.57 feet to a ½" iron rod found, without cap, for corner;
- 6) S39°00'44"E, 87.63 feet to a cotton gin spindle found for corner;
- 7) N50°49'45"E, 220.48 feet to a calculated point for the most northerly corner of the aforesaid 1.00 acre tract, being a northerly corner of the 100.467 acre tract and a point on the aforesaid southwest right-of-way line of Mathias Lane, from which a ½" iron rod, with plastic cap marked "4160", found for the most easterly corner of Lot 1 Kyle Project, LLC, a subdivision recorded in Book 16, Page 323 of the said Plat Records, bears N46°54'53"W, with the common northeast line of the said 100.467 acre tract and southwest right-of-way line of Mathias Lane, 2376.26 feet to a ½" iron rod, with plastic cap marked "Capital Surveying Company, Inc.", found and S44°32'17"W, 3.89 feet;

THENCE, S46°54'53"E, leaving the northeast line of the said 100.467 acre tract, with the common northeast line of the said 1.00 acre tract and southwest right-of-way line of Mathias Lane, for a distance of 50.47 feet to the POINT OF BEGINNING, CONTAINING within these metes and bounds 0.9999 acres of land area.

Basis of Bearing is the Texas State Plane Coordinate System, South Central Zone, NAD83 (Grid).

I, Gregory A. Way, a Registered Professional Land Surveyor, do hereby certify that the above description is true and correct to the best of my knowledge and that the property described herein was determined by a survey made on the ground under my direction and supervision.

WITNESS MY HAND AND SEAL at Austin, Travis County, Texas, this the 12th day of June, 2017.





GREGORY A. WAY
Registered Professional Land Surveyor
No. 4567 State of Texas

EXHIBIT B
CONCEPT PLAN

[See Attached]

TRAILS AT WINDY HILL EXHIBIT "B" - 6/19/2018

LEGEND

- 40' LOTS
- 50' LOTS
- 60' LOTS
- OPEN SPACE
- FENCECRETE WITH MASONRY COLUMNS
- 6' WOOD PRIVACY FENCE
- TAKEDOWN BOUNDARY

NOTE: LOCATION OF WOOD PRIVACY FENCE IS SUBJECT TO REVISION AND DELETION AS NECESSARY TO PROVIDE UNENCUMBERED CONVEYANCE OF DRAINAGE THROUGH THE SUBJECT PROPERTY

LOT TABLE

WIDTH	DEPTH (MIN)	QTY	% TOTAL
40'	120'	404	39%
50'	120'	517	51%
60'	120'	104	10%
		1025	100%

TAKEDOWN TABLE

1	80.76 AC
2	42.06 AC
3	45.49 AC
4	33.26 AC
5	40.70 AC

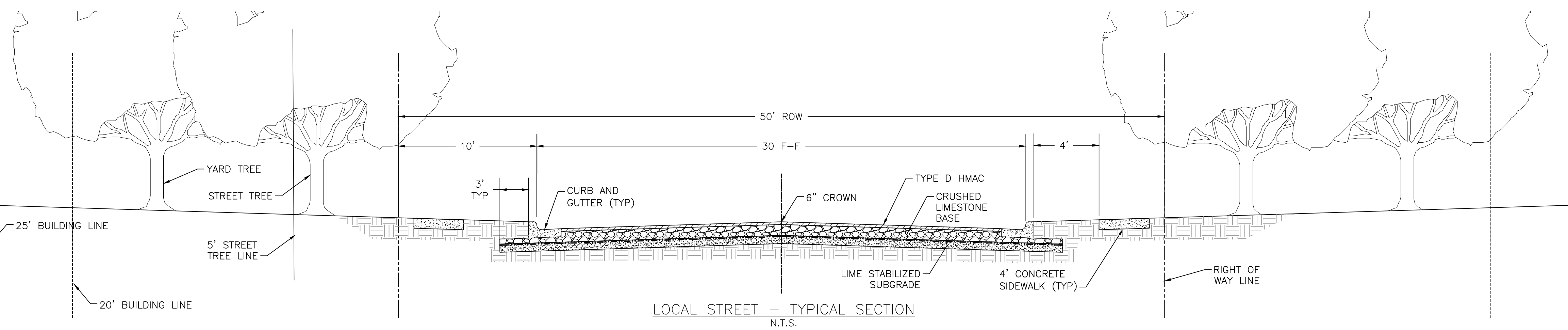

	LOT COUNT BY TAKEDOWN			TOTAL # OF LOTS
	40' LOTS	50' LOTS	60' LOTS	
TAKEDOWN 1	122	178	36	336
TAKEDOWN 2	60	82	16	158
TAKEDOWN 3	85	107	13	205
TAKEDOWN 4	61	59	22	142
TAKEDOWN 5	75	92	17	184
TOTAL	403	518	104	1025

D·R·HORTON
America's Builder

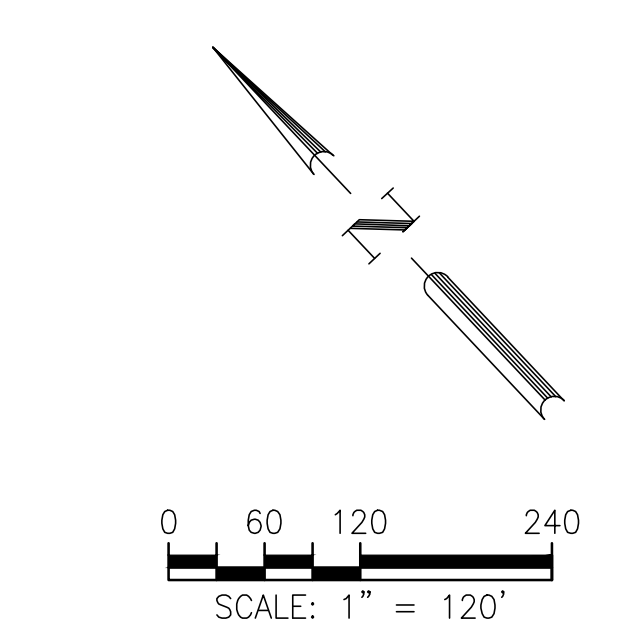

BGE
BGE, Inc.
7000 NORTH MOORE, SUITE 330
AUSTIN, TX 78731
TEL: 512-878-0400 • www.bgeinc.com
TDP# Registration No. F-1046

V:\Projects\DR_Horton\Windy_Hill\DC\180519_DA_Exhibit_B.wbak\drawing.dwg Layout - COMMUNITY MAP Plotter: 6/19/2018 12:52:21 PM

EXHIBIT C

VARIANCE TABLE

The Trails at Windy Hill Development - Kyle, Texas					
EXHIBIT C - LIST OF VARIANCES & ALTERNATIVE STANDARDS					
#	Ordinance	Description	Requirement	Requested Variance	Justification
City of Kyle - Chapter 41 Subdivisions					
1	Sec. 41-136 (a) (Chart 1)	Lots	Sets minimum lot street line width to 35 feet in R-1-A Land Use District	For those Lots which have 35% or more frontage on a full- or eyebrow cul-de-sac, the lot width will be calculated as the horizontal distance between the side lines of the lot, measured at the minimum required front yard (building setback) line.	To accommodate irregular shaped Lots that may occur at cul-de-sacs or knuckles.
2	Sec. 41-137 (c)	Streets	Provide projection of streets into future adjoining subdivisions at a minimum 1,000 feet.	Street projections will be provided approximately in accordance with the concept plan.	The current layout provides for street projection into Lots that could be subdivided in the future.
3	Sec. 41-137 (e)(1)	Streets	Minimum centerline curve radius for local streets is 275 feet.	Minimum centerline curve radius for local streets will be 200 feet.	Complies with AASHTO standards relative to proposed design speeds and Hays County requirements for urbanized local roadways.

4	Sec. 41-137 (g)(4)	Streets	Minimum curb radius 25 feet	Minimum curb radius 15 feet for local streets.	To better accommodate smaller residential lot sizes in suburban setting. Proposed curb radius meets City of Austin requirements.
5	Sec. 41-137 (k)(1)	Streets	Local street pavement width to be 30 feet and Right-of-Way width to be 60 feet.	Local street pavement width to be 28 feet and Right-of-Way width to be 50 feet.	To better accommodate smaller residential lot sizes in a suburban setting. Meets Hays County requirements for urbanized local roadways.
6	Sec. 41-137 (k)(3)	Streets	Need minimum 150 feet of divided street entrance when connecting to a collector road.	Only entry streets connecting to Windy Hill Road in Phase I will have a divided street entrance. All other streets connecting into entry collector street and Mathias Lane are not required to have a divided street entrance.	All streets connecting into Mathias Lane may be required to include possible roundabouts.
7	Sec. 41-143(a)	Sidewalks	Sidewalks shall be two feet from curb	Sidewalk shall be located two feet from the right of way	To allow room for the fire hydrants, meter boxes and cleanouts.
8	Sec. 41-134(a)(4)	Inspection of Construction	Contractor or developer to pay city's costs and expenses for the required construction inspection	Contractor or developer are not required to pay City's costs and expenses for the construction inspections. Hays County will perform all required inspections.	To avoid duplication of costs.

EXHIBIT D

TURN LANE

[See Attached]

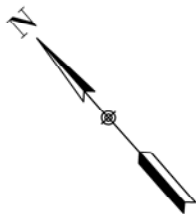

PROPOSED WINDY HILL ROAD
RIGHT TURN LANE

CIVILE, LLC
8200 N. MOPAC EXPY
SUITE 250
AUSTIN, TX 78759

OFFICE: 512-402-6878
FAX: 512-402-6947

TEXAS REGISTERED ENGINEERING FIRM F-15581



EXHIBIT E

WINDY HILL ROAD DEDICATION

[See Attached]

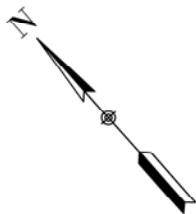

PROPOSED WINDY HILL ROAD
RIGHT-OF-WAY DEDICATION

CIVILE, LLC
8200 N. MOPAC EXPY
SUITE 250
AUSTIN, TX 78759

OFFICE: 512-402-6878
FAX: 512-402-6947



TEXAS REGISTERED ENGINEERING FIRM F-15581

EXHIBIT F

MATHIAS LANE DEDICATION

[See Attached]

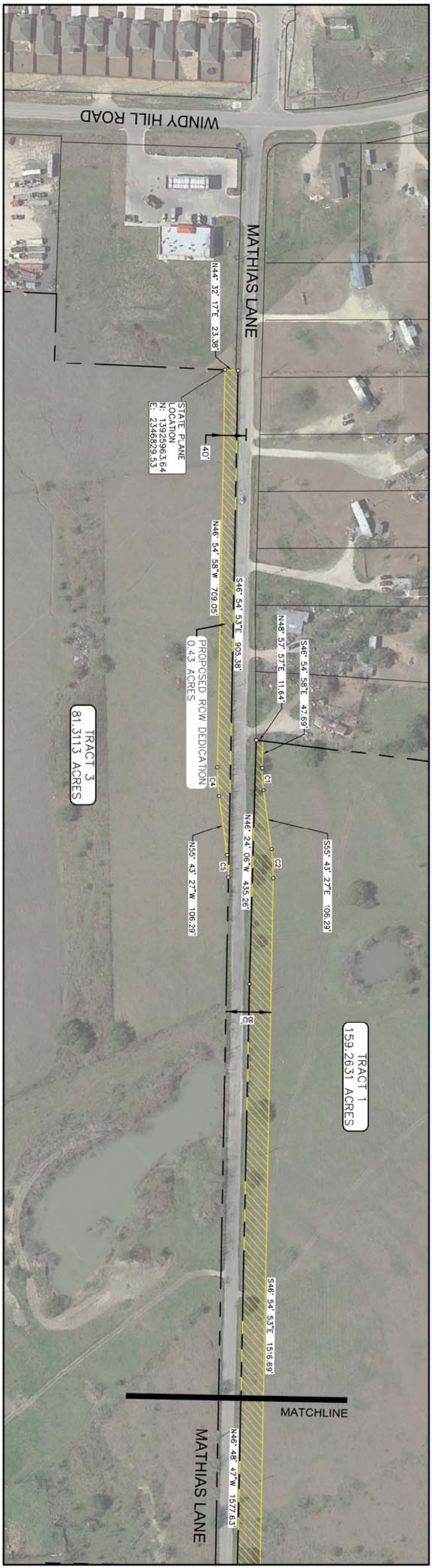

CURVE TABLE					
NUMBER	LENGTH	RADIUS	DELTA	CHORD BEARING	CHORD LENGTH
C1	39.97'	260.00'	8.809°	S91° 19' 12"E	39.93
C2	52.28'	340.00'	8.809°	S91° 19' 10"E	52.23
C3	119.54'	260.00'	26.343°	S60° 05' 11"E	118.49
C4	52.27'	340.00'	8.808°	N91° 19' 12"W	52.22
C5	39.98'	260.00'	8.809°	N91° 19' 10"W	39.94

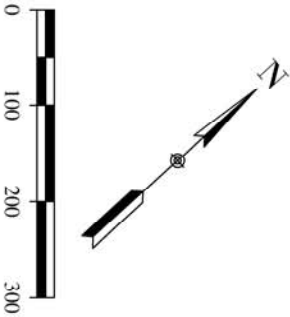

PROPOSED MATHIAS LANE
RIGHT-OF-WAY DEDICATION

CIVILE, LLC
8200 N. MOPAC EXPY
SUITE 250
AUSTIN, TX 78759
OFFICE: 512-402-6878
FAX: 512-402-6947
TEXAS REGISTERED ENGINEERING FIRM F-15581



EXHIBIT G
Out Parcel

STATE OF TEXAS §
 §
COUNTY OF HAYS §

FIELDNOTE DESCRIPTION of a 22.606 acre tract out of the Z. Hinton Survey No. 4, Abstract No. 219 in Hays County, Texas, being a portion of that 161.170 acre tract, described as Exhibit A, as conveyed to D. E. and Nova Crumley Family Limited Partnership by deed recorded in Volume 1508, Page 697 of the Official Public Records of Hays County, Texas; the said 22.606 acre tract is more particularly described by metes and bounds as follows:

BEGINNING, at a ½" iron rod, with plastic cap marked "Capital Surveying Company, Inc.", found for the easterly corner of the said 161.170 acre tract, being the southwest line of that 190.258 acre tract, described as Tract 3, conveyed to Studio Estates, LLC, by deed recorded in Volume 5063, Page 491 of the said Official Public Records and the most northerly corner of Meadow Vista, Section 2, a subdivision recorded in Book 11, Page 85 of the said Plat Records;

THENCE, S43°37'40"W, leaving the southwest line of the said 190.258 acre tract, with the common southeast line of the 161.170 acre tract and northwest line of Meadow Vista, Section 2, subdivision, 1160.59 feet to a ½" iron rod, with plastic cap marked "Carson and Bush", found for the most easterly corner of Foster Place, Section Two, a subdivision recorded in Book 12, Page 176 of the said Plat Records, from which a ½" iron rod, with plastic cap marked "Carson and Bush", found for the most westerly corner of aforesaid Meadow Vista, Section 2, subdivision, being the most northerly corner of Meadow Vista, Section 1, a subdivision recorded in Book 9, Page 40 of the said Plat Records and a point on the southeast line of said Foster Place, Section Two, subdivision, bears S43°01'20"W, 18.77 feet;

THENCE, leaving the northwest line of said Meadow Vista, Section 2, subdivision, across the said 161.170 acre tract, with the northerly line of said Foster Place, Section Two, subdivision, for the following two (2) courses:

- 1) N46°25'05"W, 231.26 feet to a ½" iron rod, with plastic cap marked "Carson and Bush", found for corner;
- 2) S43°46'50"W, 123.48 feet to a ½" iron rod, with plastic cap marked "Capital Surveying Company, Inc.", found for corner, from which a ½" iron rod, with plastic cap marked "Carson and Bush, found for an angle point on the aforesaid Foster Place, Section Two, subdivision, bears S43°46'50"W, 47.25 feet;

THENCE, leaving the northwest line of Foster Place, Section Two, subdivision and continuing across the said 161.170 acre tract, for the following four (4) courses:

- 1) N46°13'10"W, 143.00 feet to a ½" iron rod, with plastic cap marked "Capital Surveying Company, Inc.", found for corner;

Attachment A

- 2) S43°46'50"W, 215.28 feet to a calculated point of non-curvature of a curve to the right, on the westerly Niederwald City Extraterritorial Jurisdiction (ETJ) line, from which a ½" iron rod, with plastic cap marked "Capital Surveying Company, Inc.", found on the southwest line of the aforesaid 161.170 acre tract, same being the northeast right-of-way line of existing Mathias Lane, bears S43°46'50"W, 128.91 feet;
- 3) With said curve to the right, having a central angle of 00°38'27", a radius of 2640.00 feet, a chord distance of 29.53 feet (chord bears N08°11'42"E), for an arc distance of 29.53 feet, to a calculated point of non-curvature of a curve to the left, at the intersection of the westerly line of the Niederwald City ETJ and the easterly line of the Kyle City ETJ;
- 4) With said curve to the left, having a central angle of 08°05'23", a radius of 11604.00 feet, a chord distance of 1637.03 feet (chord bears N17°04'46"E), for an arc distance of 1638.39 feet, to a calculated point on the common northeasterly line of the aforesaid 161.170 acre tract and the southwesterly line of said 190.258 acre tract, from which a 1/2" iron rod, without cap, found on the said northeasterly line of the 161.170 acre tract, for the southerly corner of Lot 4, Block 3, Rolling Hills Estates, Section 2, recorded in Book 1, Page 215, of the said Plat Records, bears N46°54'58"W, 1453.54 feet;

THENCE, S46°54'58"E, leaving the westerly line of said Kyle City ETJ, with the northeast line of the said 161.170 acre tract, being the southwest line of the 190.258 acre tract, for a distance of 1124.01 feet to the POINT OF BEGINNING, CONTAINING within these metes and bounds 22.606 acres of land area.

Basis of Bearing is the Texas State Plane Coordinate System, South Central Zone, NAD83 (Grid).

I, Gregory A. Way, a Registered Professional Land Surveyor, do hereby certify that the above description is true and correct to the best of my knowledge and that the property described herein was determined by a survey made on the ground under my direction and supervision.

WITNESS MY HAND AND SEAL at Austin, Travis County, Texas, this the 26th day of October, 2017.

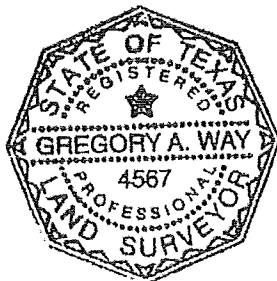

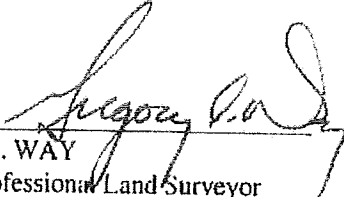
GREGORY A. WAY
Registered Professional Land Surveyor
No. 4567 State of Texas

**SKETCH TO ACCOMPANY A DESCRIPTION
OF A 22.606 ACRE TRACT
OUT OF THE Z. HINTON SURVEY No. 4,
ABSTRACT No. 219
HAYS COUNTY, TEXAS**

190.258 AC.
TRACT 3
STUDIO ESTATES LLC
Vol. 5063, Pg. 491
O.P.R.H.C.

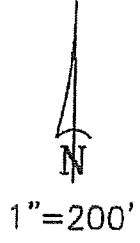

SEE NOTE 2 → $\Delta=08^{\circ}05'23''$
 $R=11604.00'$
 $A=1638.39'$
 $C=1637.03'$
 $Cb=N17^{\circ}04'46''E$
(*SEE NOTE 2)

Z. HINTON SURVEY NO. 4
ABSTRACT NO. 219

$S46^{\circ}54'58''E$ 1124.01' $(N46^{\circ}29'09''W$ 1394.11')
 $(S46^{\circ}19'10''E$ 2576.89')

22.606 AC.

POINT OF BEGINNING

$\Delta=00^{\circ}38'27''$
 $R=2640.00'$
 $A=29.53'$
 $C=29.53'$
 $Cb=N08^{\circ}11'42''E$
(*SEE NOTE 3)

(161.170 ACRES)
EXHIBIT A - (TRACT 5)
D.E. AND NOVA CRUMLEY
FAMILY LIMITED PARTNERSHIP
Vol. 1508, Pg. 697
O.P.R.H.C.

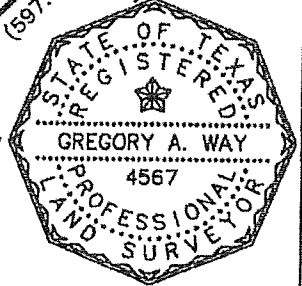

I, Gregory A. Way, a Registered Professional Land Surveyor do hereby certify that the above map or plat is true and correct to the best of my knowledge prepared from an on the ground survey done in June, 2017.

WITNESS MY HAND AND SEAL at Austin, Travis County, Texas this the 26th day of October, 2017.

Gregory A. Way
GREGORY A. WAY
Registered Professional Land Surveyor
No. 4567 - State of Texas

16525ETJ.DWG	SHEET 3 of 4
ESE	
925 Capital of Texas Highway South Building B, Suite 115 Austin, Texas 78748 (512) 327-4008	
FIRM REGISTRATION No. 101267-G	

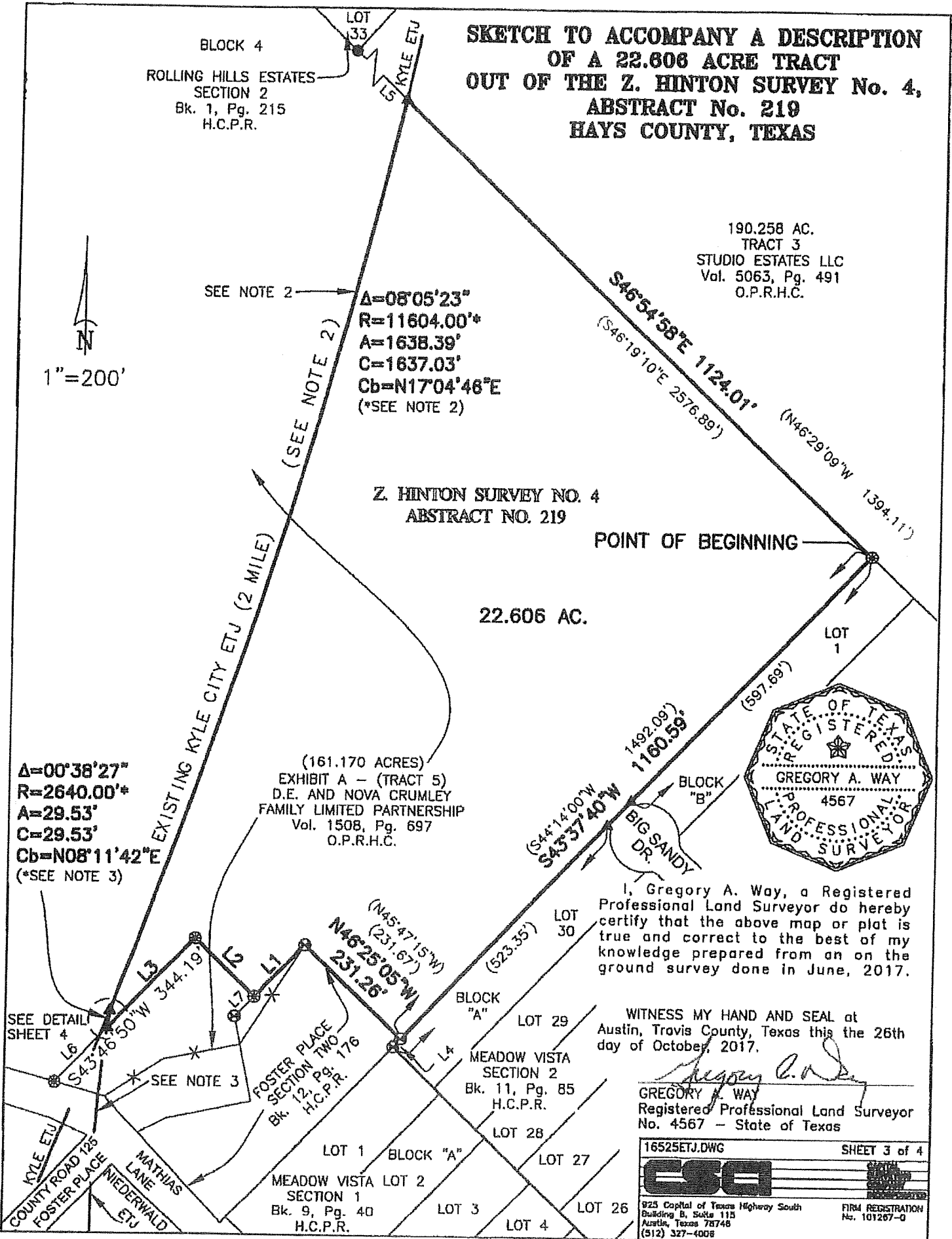

**SKETCH TO ACCOMPANY A DESCRIPTION
OF A 22.606 ACRE TRACT
OUT OF THE Z. HINTON SURVEY No. 4,
ABSTRACT No. 219
HAYS COUNTY, TEXAS**

LEGEND

- O.P.R.H.C. OFFICIAL PUBLIC RECORDS HAYS COUNTY
- H.C.P.R. HAYS COUNTY PLAT RECORD
- H.C.D.R. HAYS COUNTY DEED RECORD
- P.R.H.C. HAYS COUNTY PLAT RECORDS
- R.O.W. RIGHT OF WAY
- () RECORD TEXT
- ▲ CALCULATED POINT
- 1/2" IRON ROD FOUND WITHOUT CAP
- 1/2" IRON ROD SET WITH PLASTIC CAP MARKED "CAPITAL SURVEYING CO. INC."
- ⊗ 1/2" IRON ROD FOUND WITH PLASTIC CAP MARKED "CAPITAL SURVEYING CO. INC."
- ⊙ 1/2" IRON ROD FOUND WITH CAP MARKED "CARSON AND BUSH"
- X— WIRE FENCE
- /— BREAK LINE

LINE TABLE		
LINE	BEARING	LENGTH
L1	S43°46'50"W	123.48'
L2	N46°13'10"W	143.00'
L3	S43°46'50"W	215.28'
L4	S43°01'20"W	18.77'
L5	N46°54'58"W	1453.54'
L6	S43°46'50"W	128.91'
L7	S43°46'50"W	47.25'

Note:

1. Basis of Bearing: The Bearings shown hereon are based on the Texas State Plane Coordinate System, South Central Zone (NAD83/Grid) as derived from GPS observation.
2. The Kyle City ETJ (2 mile) is based on the easterly line of the existing Kyle City Limit line which is 1104 feet (derived from CAD drawing of existing city limits as provided) from the found southeasterly fence corner of Lot 4, Guinea Hills Estates, Section 2, (grid coordinates shown below), recorded in Bk. 3, Pg. 151, P.R.H.C. (northwest corner of the intersection of Dacy Lane and Kelly Smith Lane).
N 13927849.833
E 2339222.697
3. The Niederwald City ETJ (0.5 mile) is based on the found fence corner at the southwesterly corner of that certain 275.85 acre tract (grid coordinates shown below) conveyed to Studio Estates, LLC, by deed recorded in Document No. 04036494 of the O.P.R.H.C. (northeast corner of the intersection of Goforth Road and Rohde Road).
N 13923276.803
E 2352658.241

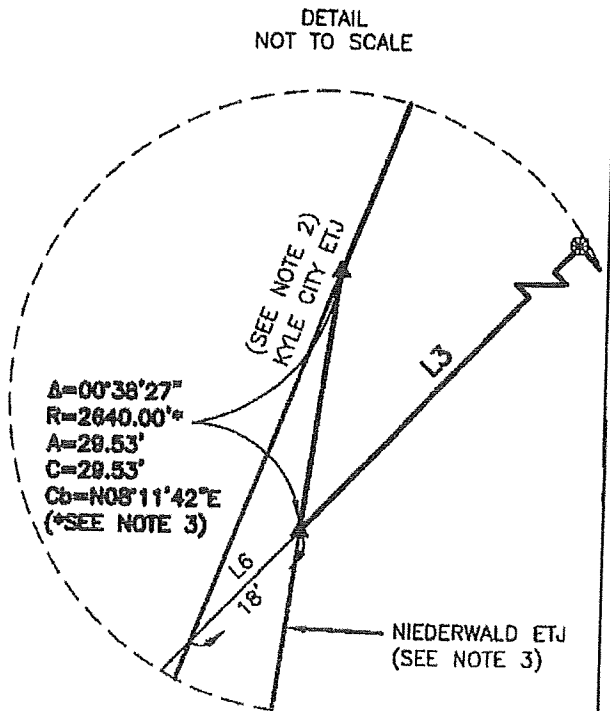

EXHIBIT H
Petition for Annexation into ETJ

(seal)

STATE OF TEXAS §
 §
COUNTY OF HAYS §

PETITION FOR VOLUNTARY ETJ EXPANSION

To the Honorable Mayor and City Council of the City of Kyle:

The undersigned represent the owner(s) of a tract of land more fully described in Exhibit A, which is attached and incorporated herein for all purposes (the "tract"). The undersigned petitions the City of Kyle to extend the present extraterritorial jurisdiction ("ETJ") so as to include the tract in its entirety.

The undersigned certifies and swears that:

1. The undersigned is the sole owner of the tract;
2. The tract is contiguous and adjacent to the City of Kyle ETJ, as it exists upon the date of the execution of this petition;
3. The tract is not located within the ETJ of any other municipality; and
4. This request for inclusion in the City of Kyle' ETJ is voluntary.

The Trails, LLC, a Texas Limited Liability Company

BY: _____

STATE OF TEXAS §
 §
COUNTY OF HAYS §

This instrument was acknowledged before me on _____, 2018, by _____, _____ of The Trails, LLC, a Texas limited liability company, on behalf of the limited liability company.

Notary Public Signature

Instrument # 18036144 Number of Pages: 43
Filed and Recorded: 10/10/2018 12:02 PM
Liz Q. Gonzalez, Hays County Clerk, Texas
Rec \$194.00 Deputy Clerk: KBOGGUS